

A guide to your Everyday Sofa →



Life's better together.
Please assemble
with two people.



4 Seater High Arm Sofa with Chaise

Total boxes: 6

1 BOX

QTY	ITEM
-----	------

1

High Arm Seat Module

ITEM SKU: MSHASE

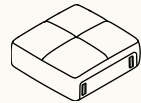

1 BOX

QTY	ITEM
-----	------

1

High Arm Chaise Module

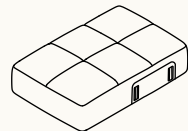

ITEM SKU: MSHACHSE



4 Seater High Arm Sofa with Chaise

Total boxes: 6

2 BOXES

QTY	ITEM	
4	High Arm Back Module <small>ITEM SKU: MSHAARBK</small>	
2	Scatter Cushion <small>ITEM SKU: MSHAARBK</small>	

4 Seater High Arm Sofa with Chaise

Total boxes: 6

1 BOX

QTY ITEM

1

Armless Seat Module

ITEM SKU: MSARSE

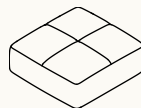

1 BOX

QTY ITEM

1

Armless Back Module

ITEM SKU: MSARBK



1

Scatter Cushion

ITEM SKU: MSARBK

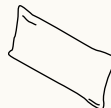

4 Seater High Arm Sofa with Chaise Covers

Total boxes: 1

BAG 1

QTY	ITEM
-----	------

1

High Arm Seat Cover

ITEM SKU: MSHASE-COV

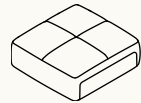

BAG 2

QTY	ITEM
-----	------

1

High Arm Chaise Cover

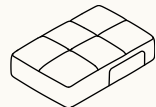

ITEM SKU: MSHACHSE-COV



4 Seater High Arm Sofa with Chaise Covers

Total boxes: 1

BAGS 3 & 4

QTY	ITEM	
4	High Arm Back Cover <small>ITEM SKU: MSHAARBK-COV</small>	
2	Scatter Cushion Cover <small>ITEM SKU: MSHAARBK-COV</small>	

4 Seater High Arm Sofa with Chaise Covers

Total boxes: 1

BAG 5

QTY ITEM

1

Armless Seat Cover
ITEM SKU: MSARSE-COV

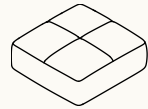

BAG 6

QTY ITEM

1

Armless Back Cover
ITEM SKU: MSARBK-COV



1

Scatter Cushion
ITEM SKU: MSARBK-COV



Let's put the cover on the Seat Module.

The following steps apply to Low Arm Seat, High Arm Seat, Armless Seat, High Arm Chaise, Low Arm Chaise and Ottoman modules.

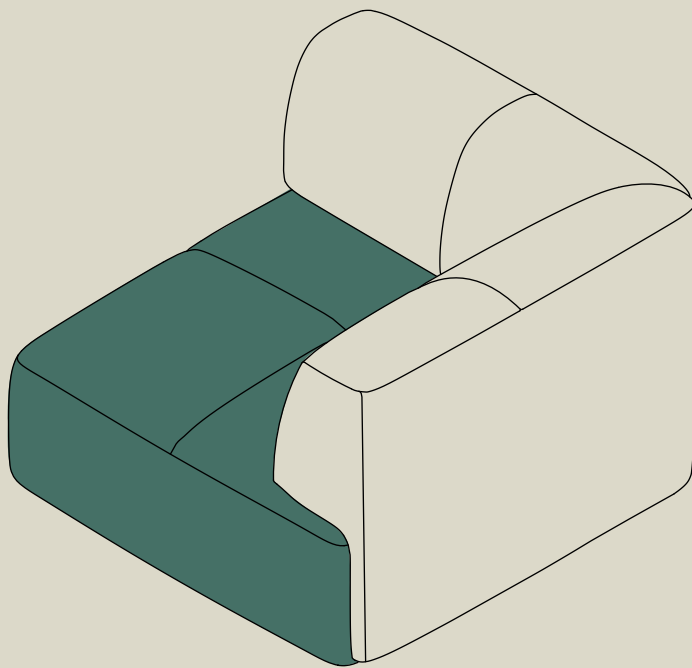

STEP 01

Identify the seat cover by the label on the bottom.

Ensure the labels on your seat module and cover match.

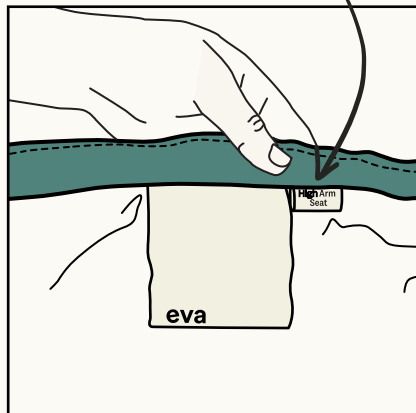
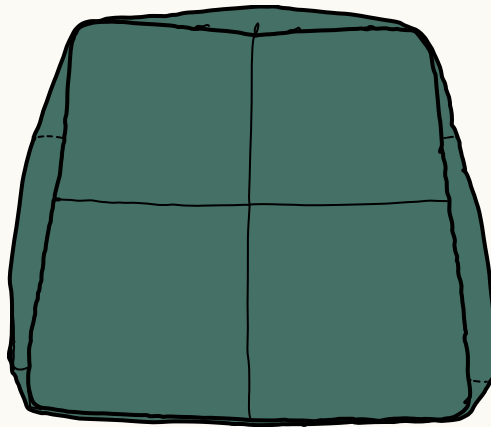
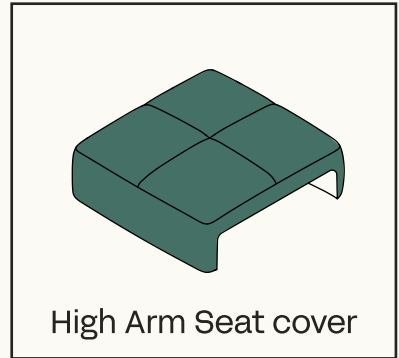

STEP 02

Place the cover on top of the High Arm Seat Module as seen below.



The cover opening should frame the seat module brackets.

STEP 03

Fix the covers tightly over each corner of the High Arm Seat Module.

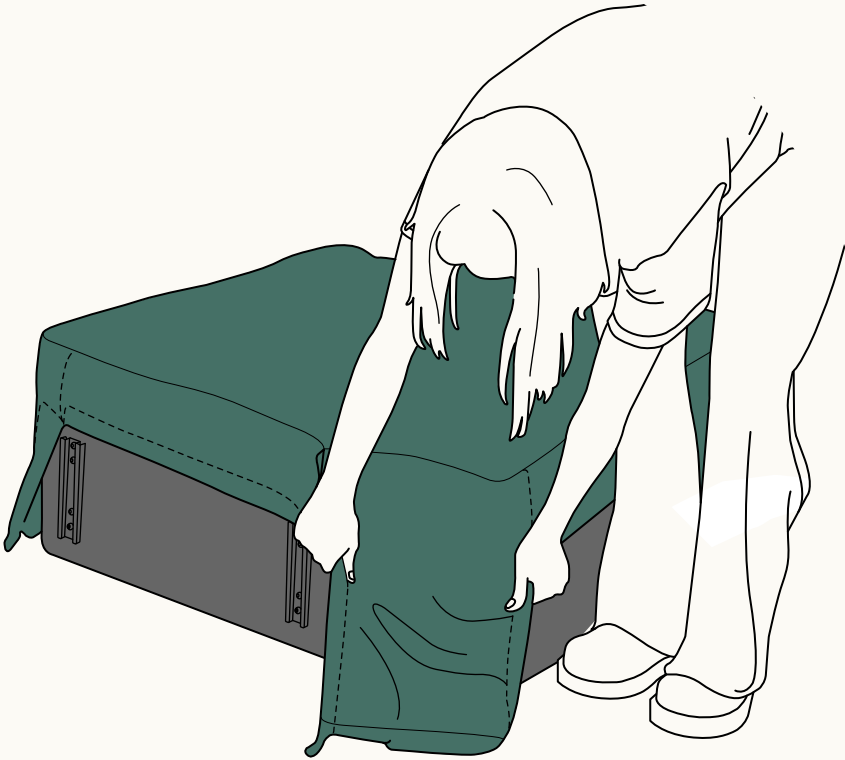

STEP 04

Flip the High Arm Seat
Module upside down.

Unfold the hook and loop
along all edges of the cover
and fix the covers to the
base of the module.

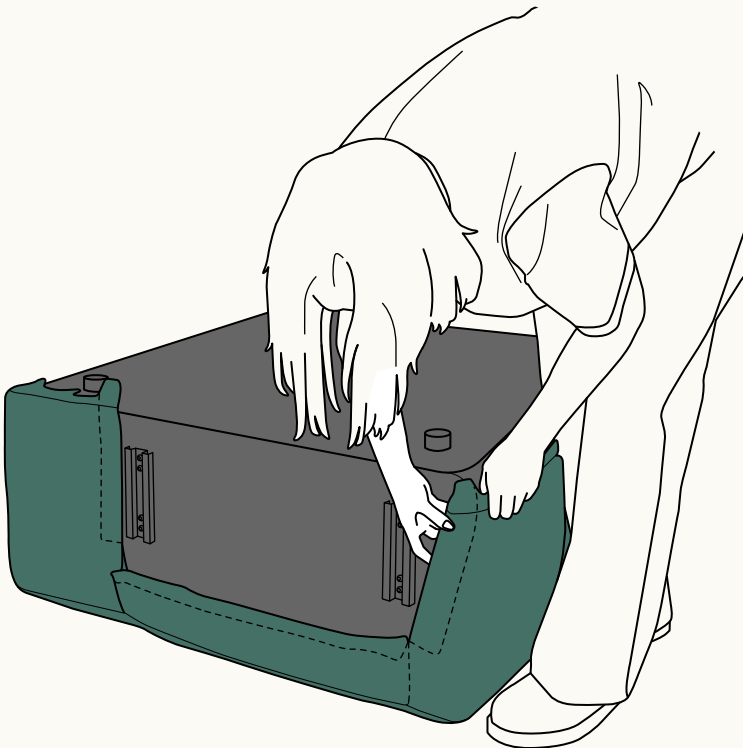
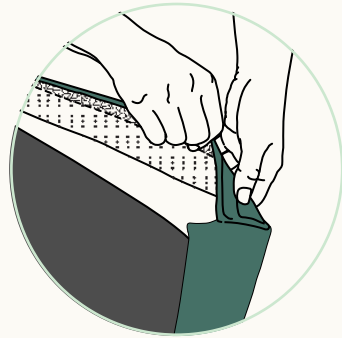

STEP 05

Attach the cover to the High Arm Seat Module by securing each edge along the sides.

Slide the cover into the groove on top of the brackets to prevent them from snagging.

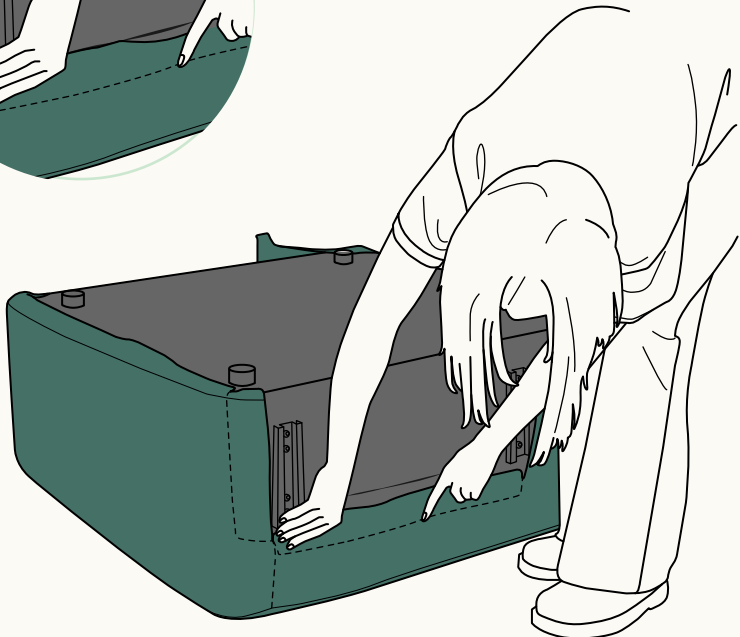

STEP 06

If the cover's wrinkle, easily smooth them by laying a towel over the fabric and gently ironing out any visible creases.

Please follow the care label instructions on your cover's for ideal heat settings.

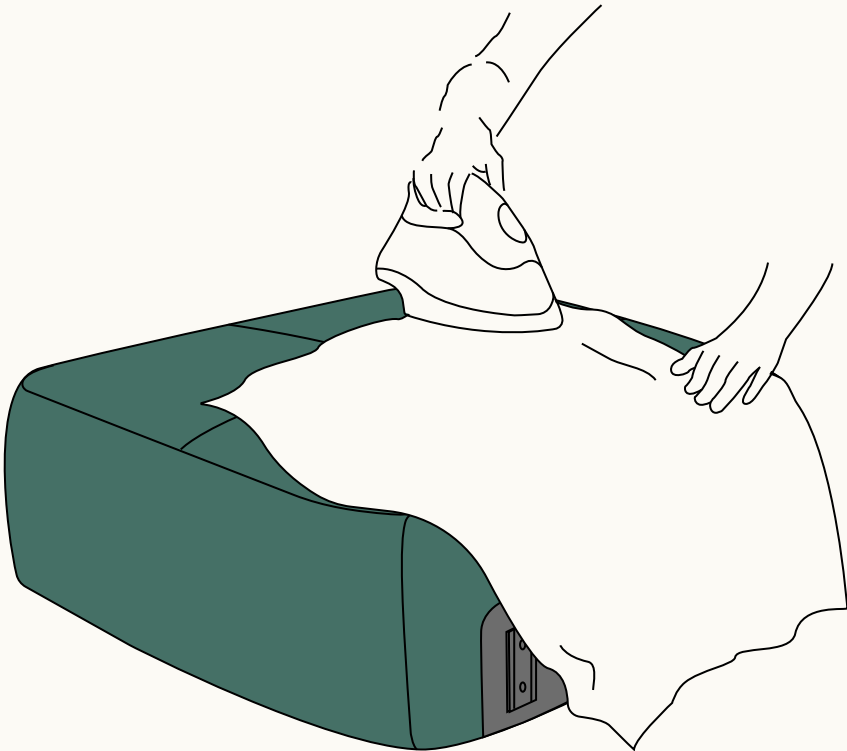

Repeat these steps to assemble the covers to the other half of the sofa.

Once your Seat covers are on, let's move onto the High Arms.

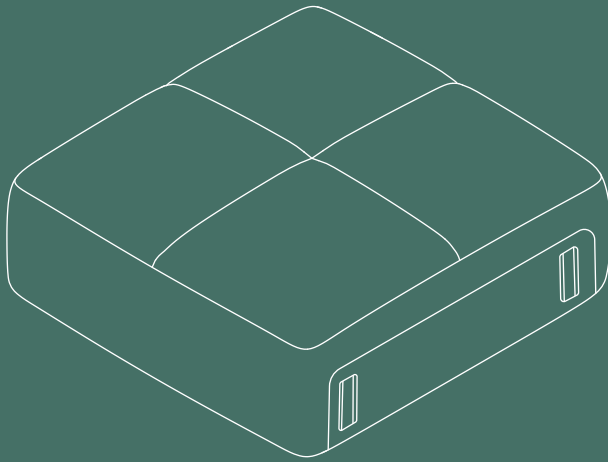

Let's put the cover
on the High Arm Modules.

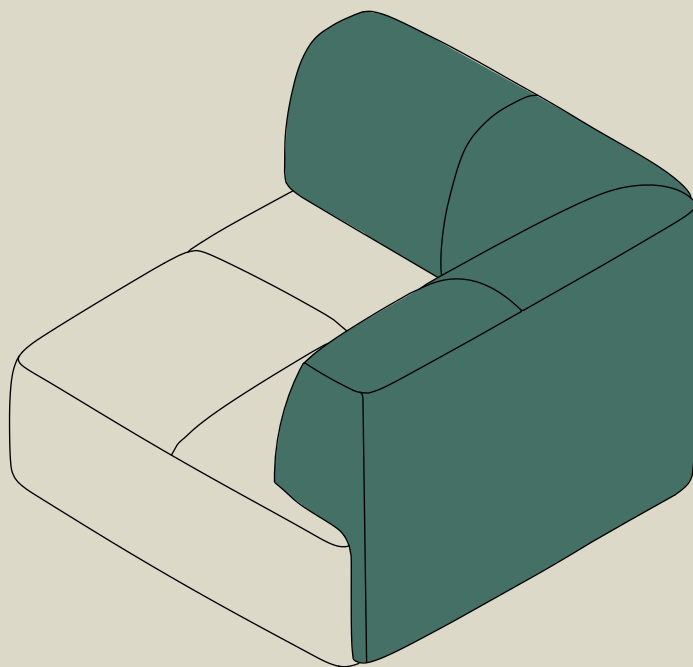

STEP 01

Identify the High Arm cover by the label on the bottom.

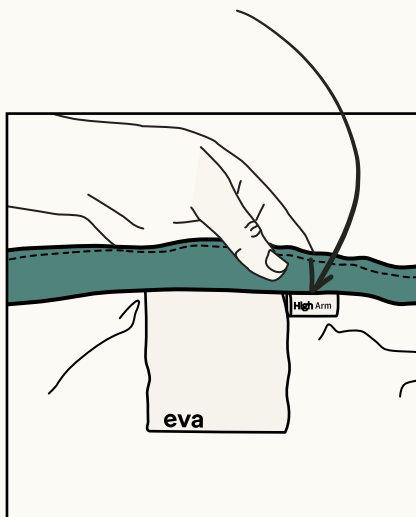
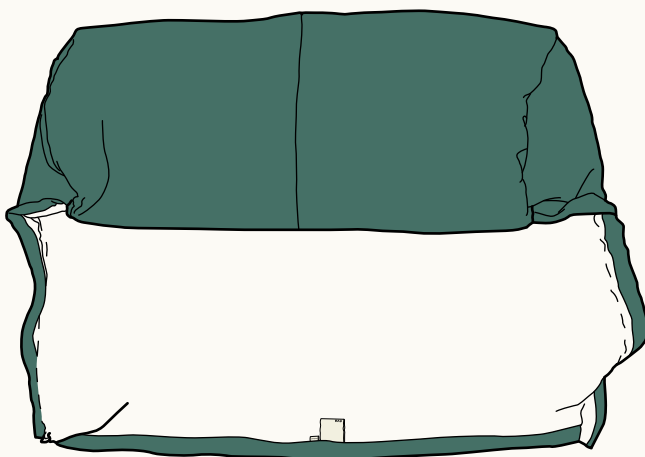
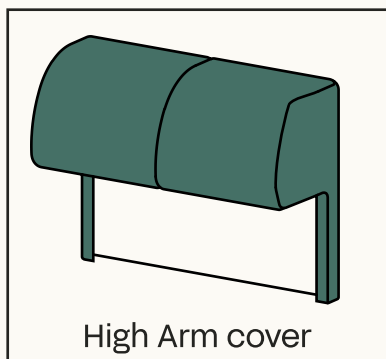

STEP 02

Dress the top part first, starting by roughly fitting one side.

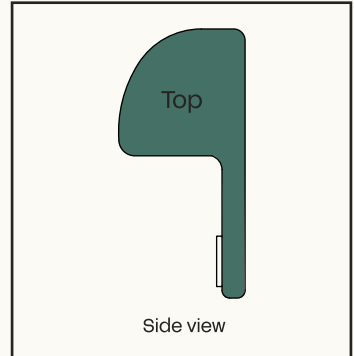

Leave this side partially attached. Do not push the cover all the way down yet.

STEP 03

Fit both sides alternately until the whole top part is fixed onto the module.

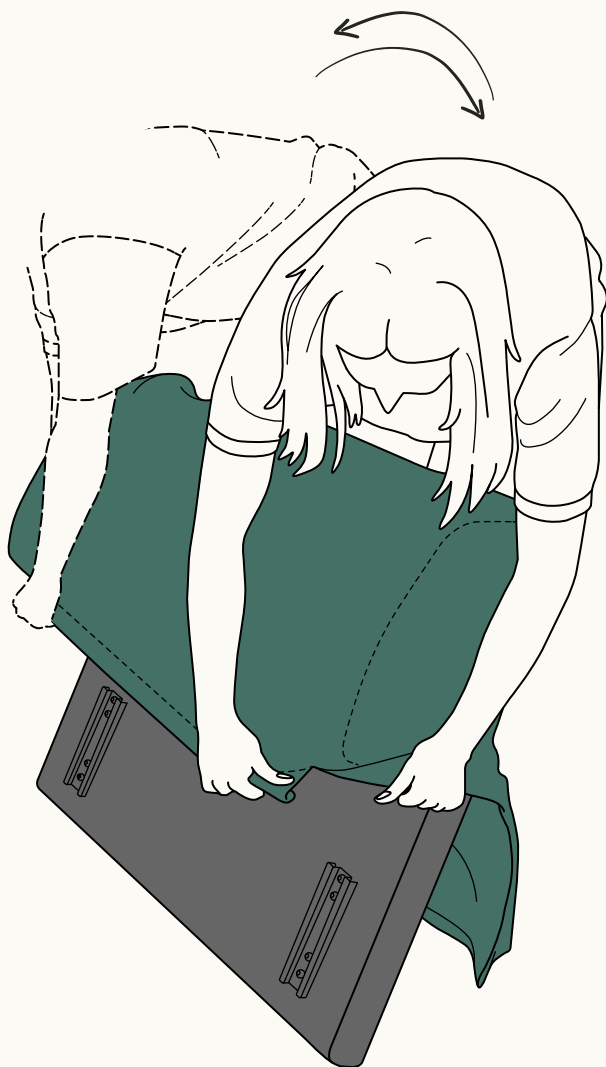

STEP 04

Flip the High Arm module upside down and pull the cover over the bottom of the High Arm.

Unfold the hook and loop along all edges of the cover.

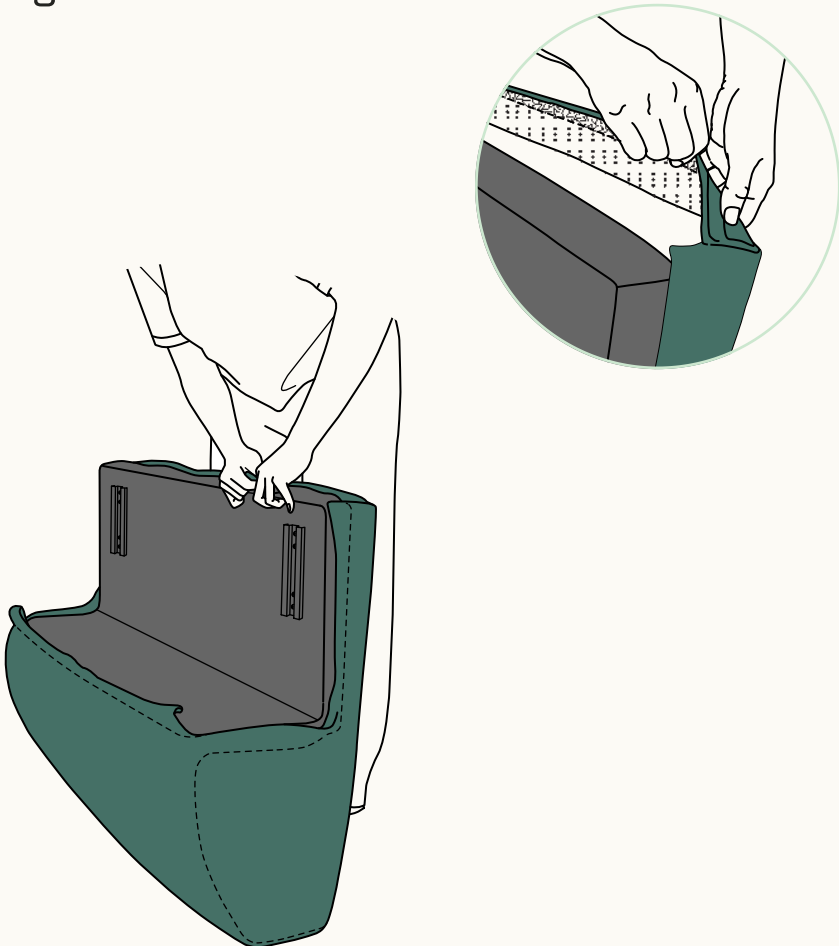

STEP 05

Adjust the cover seams to align neatly with the High Arm's edges.

Secure all hook and loop to finish the cover installation.



STEP 06

If the cover's wrinkle, easily smooth them by laying a towel over the fabric and gently ironing out any visible creases.

Please follow the care label instructions on your cover's for ideal heat settings.



Repeat these steps to dress the remaining High Arm Modules.

Once your High Arm covers are on, let's move to assembling your sofa.

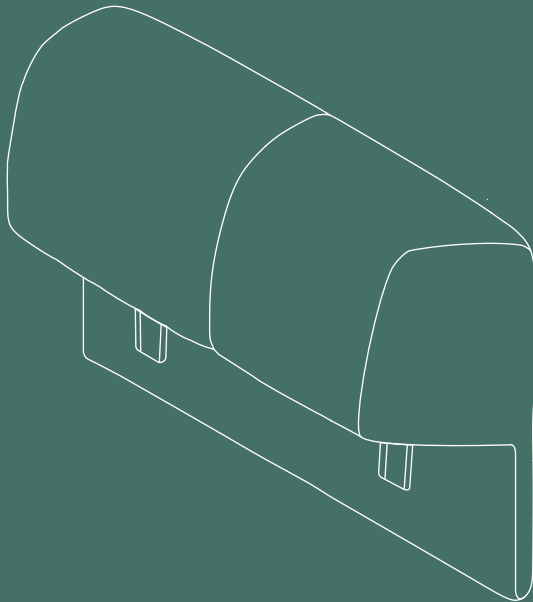

First, let's assemble
the High Arm Section.

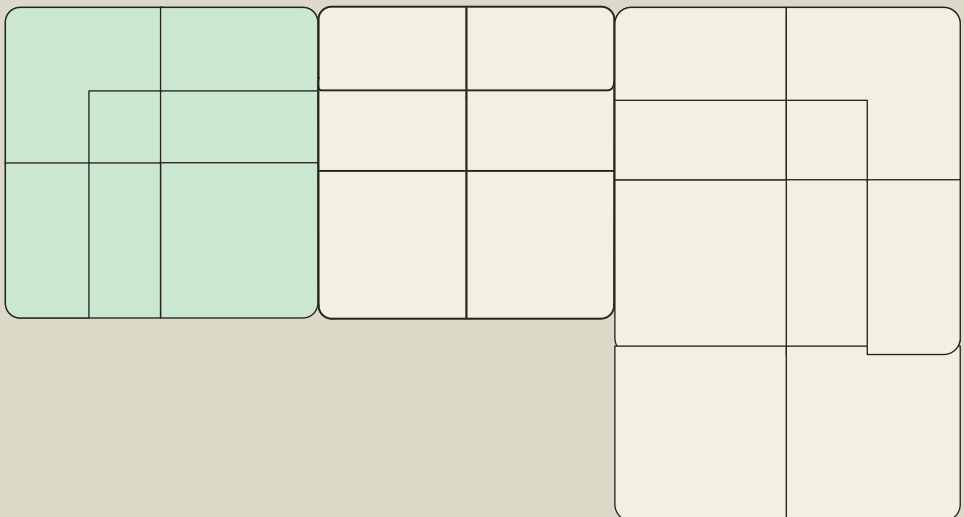

STEP 01

Align the brackets between the High Arm and the Seat and slide into place.

We recommend having one person slide the High Arm piece on whilst the other holds the Seat in place.

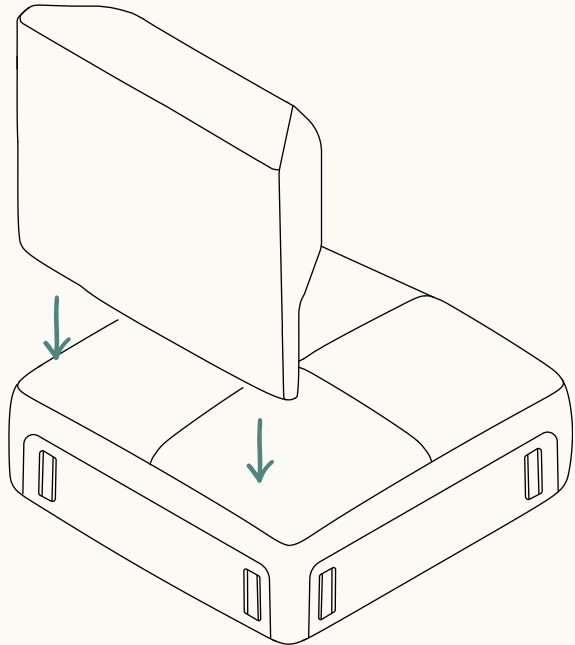
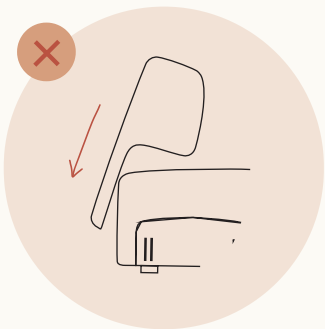
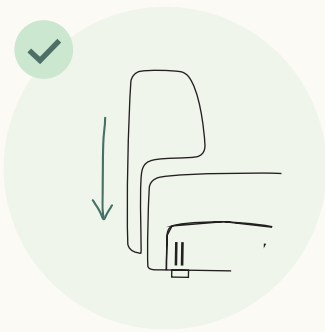

STEP 02

Align the brackets between the High Arm and the Seat and slide into place.

We recommend having one person slide the High Arm piece on whilst the other holds the Seat in place.

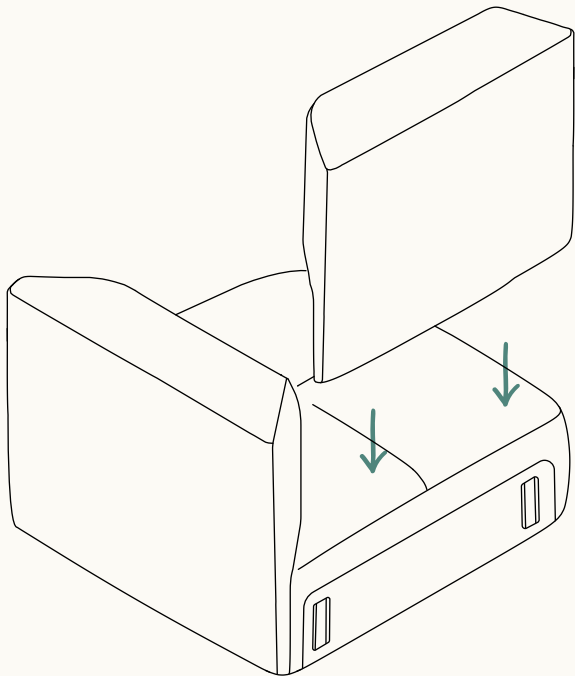

STEP 03

This module is now assembled.

Great job!

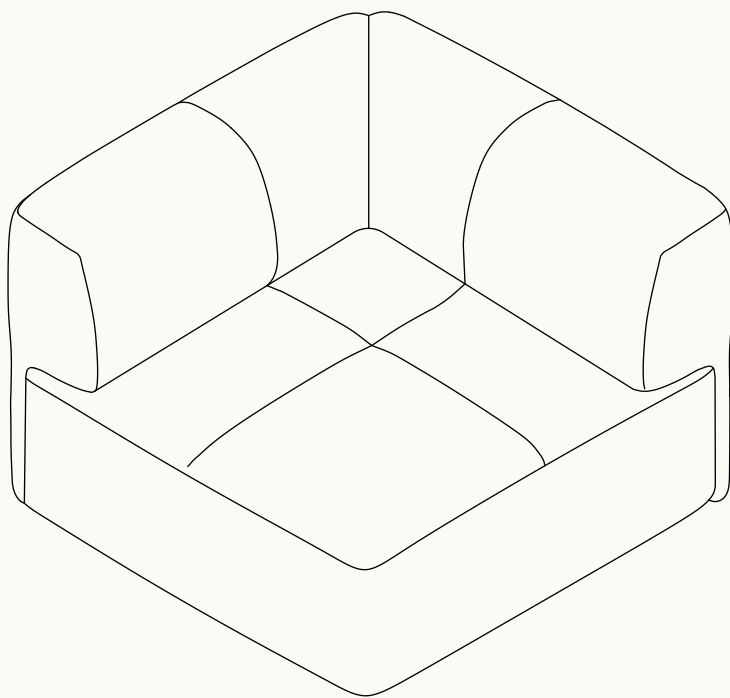

STEP 01

Align the brackets between the Backrest and the Chaise and slide into place.

We recommend having one person slide the Backrest piece on whilst the other holds the Chaise in place.

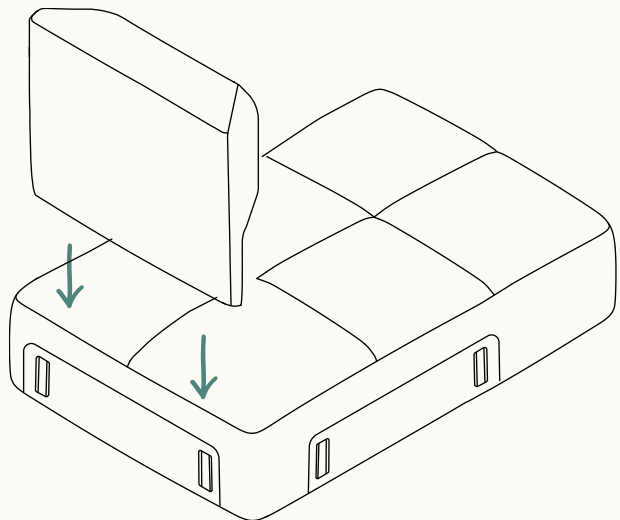
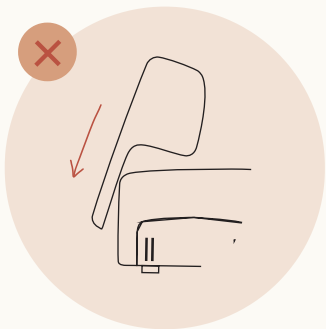
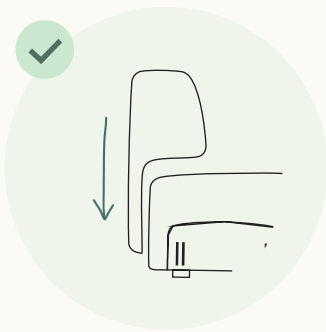

STEP 02

Align the brackets between the High Arm and the Chaise and slide into place.

We recommend having one person slide the High Arm piece on whilst the other holds the Chaise in place.

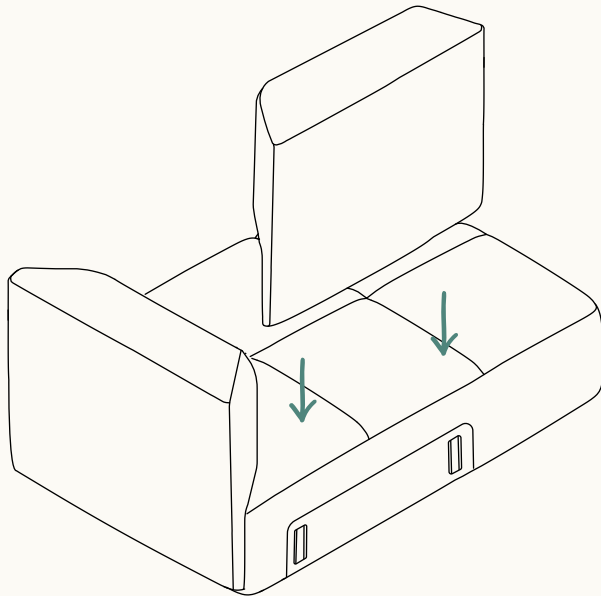

STEP 03

This module is now assembled.

Great job!

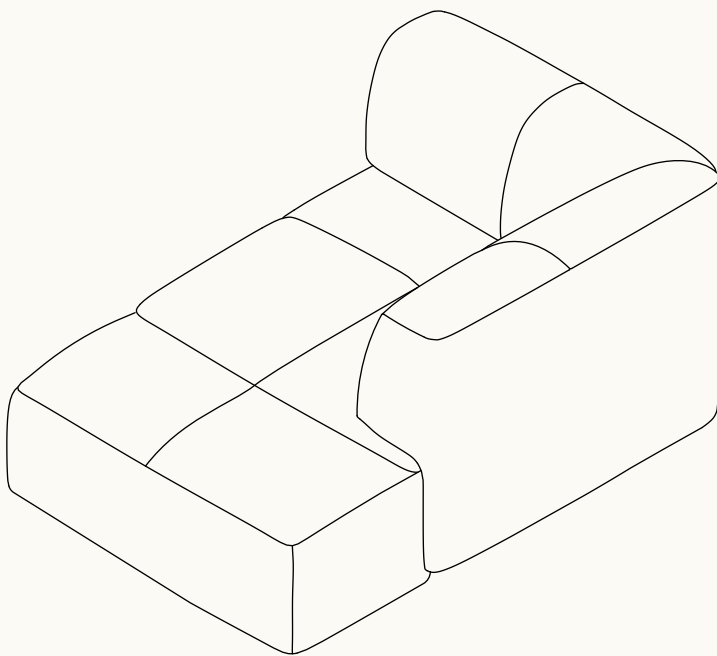

Now let's assemble the middle section.

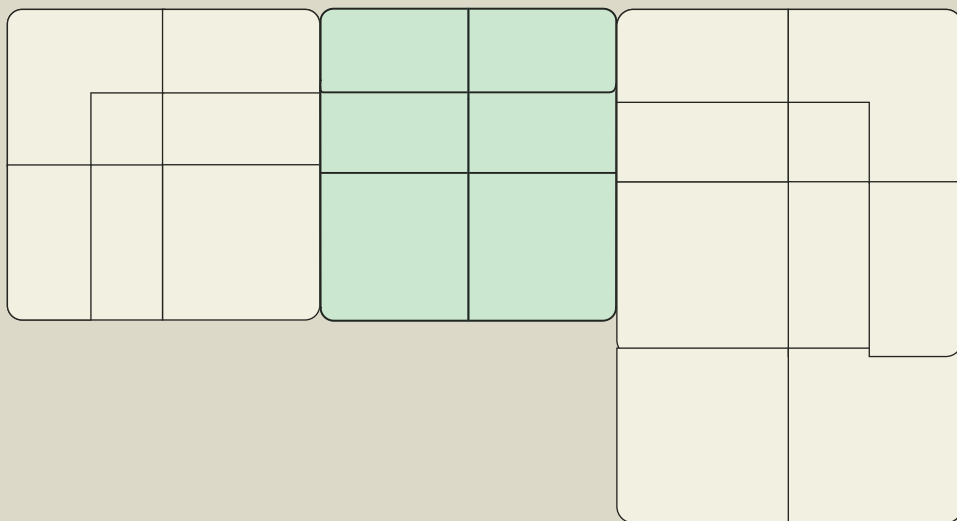

STEP 01

Align the brackets between the Backrest and the Seat and slide into place.

We recommend having one person slide the Backrest piece on whilst the other holds the Seat in place.

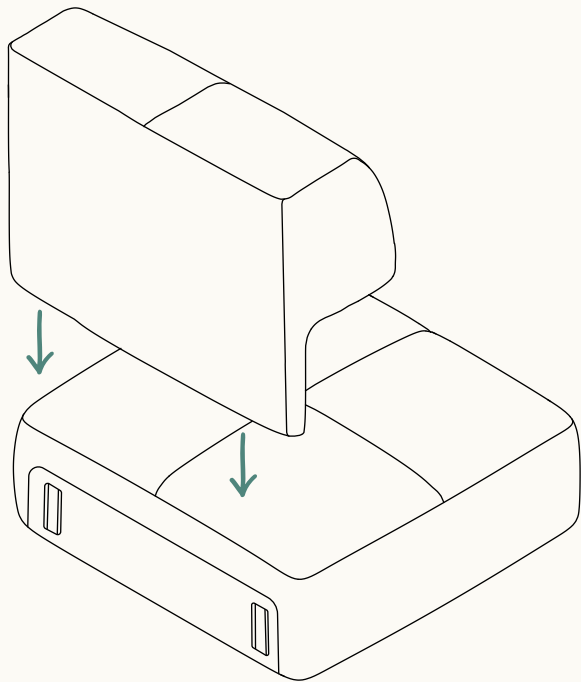
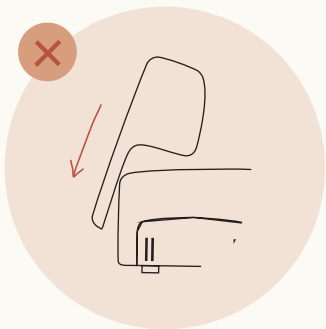
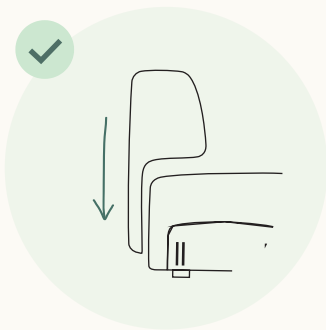

STEP 02

This module is now assembled.

Great job!

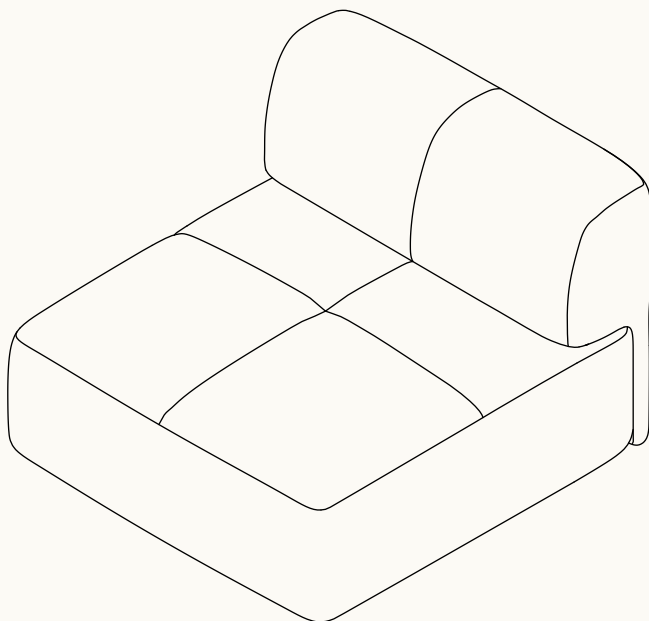

Now let's assemble your sofa.

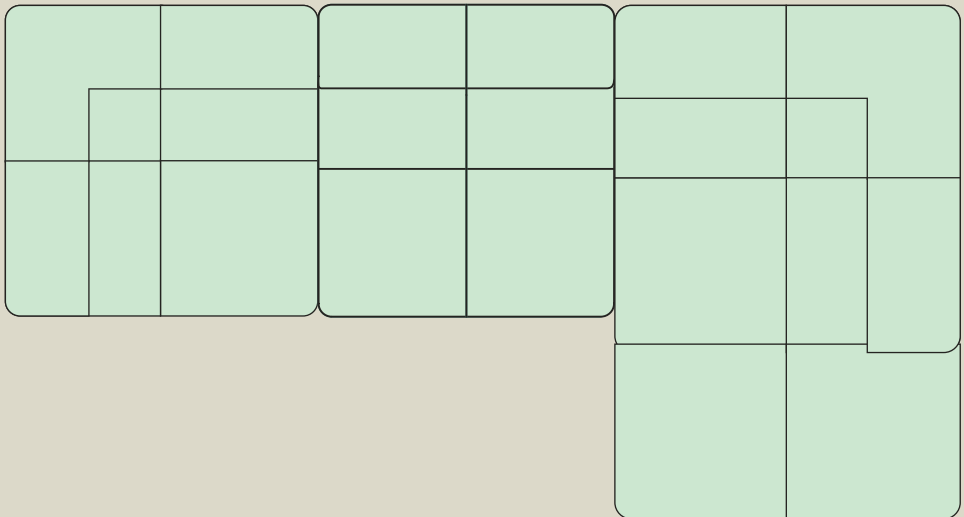

STEP 01

Rotate the connector
brackets out.

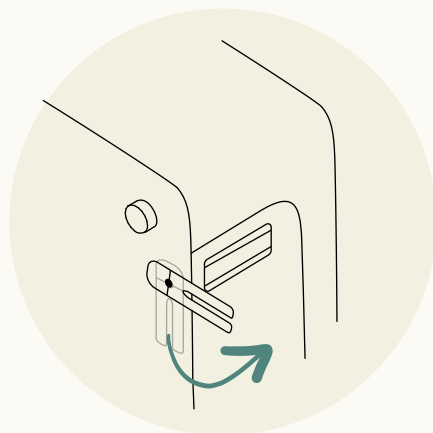
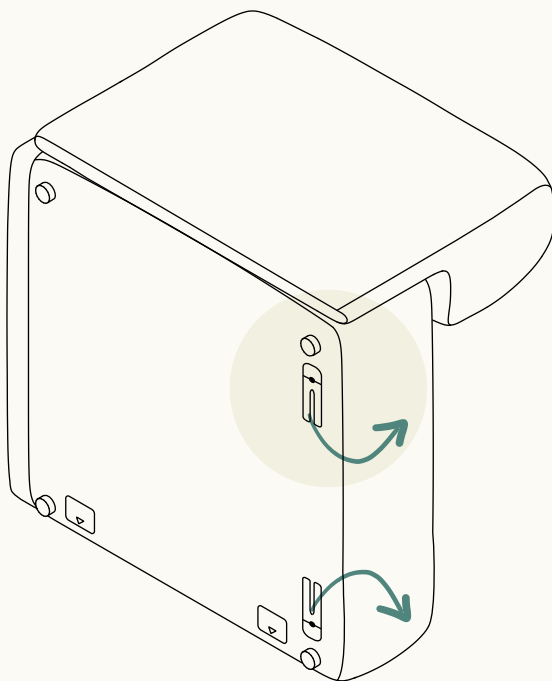

STEP 02

Align connectors and push modules together.

The connectors will click together and lock the modules into place.

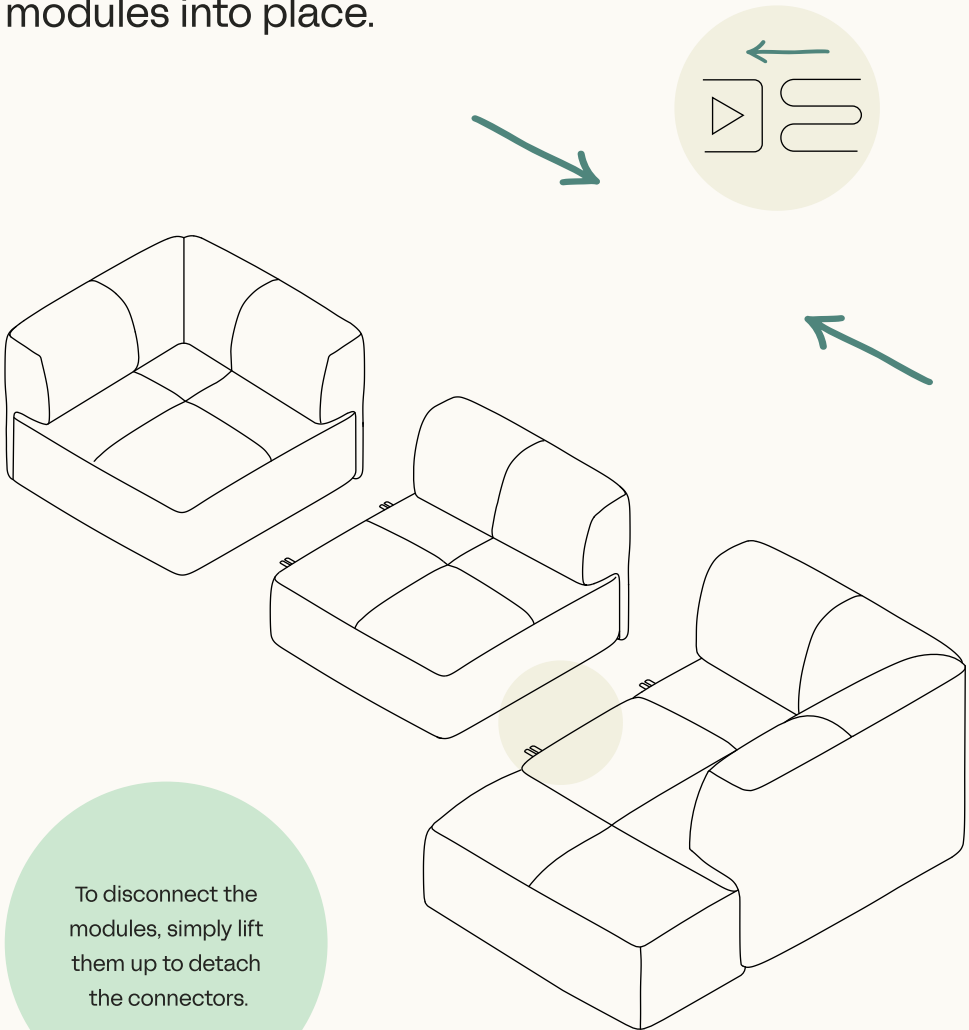

To disconnect the modules, simply lift them up to detach the connectors.

It's time to sit back and relax! Add your scatter cushions and enjoy your Everyday Sofa!

