

# A guide to your Everyday Sofa →



Life's better together.  
Please assemble  
with two people.



# 2.5 Seater Low Arm Sofa with Chaise

Total boxes: 4

## 1 BOX

QTY	ITEM
-----	------

---

1	Low Arm Seat Module
---	---------------------

ITEM SKU: MSLASE

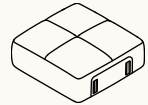

## 1 BOX

QTY	ITEM
-----	------

---

1	Low Arm Chaise Module
---	-----------------------

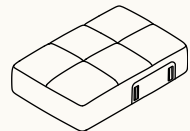

ITEM SKU: MSLACH9E



# 2.5 Seater Low Arm Sofa with Chaise

Total boxes: 4

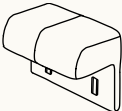
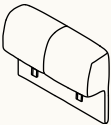
## 2 BOXES

QTY	ITEM	
2	<b>Low Arm Module</b> <small>ITEM SKU: MSLAARBK</small>	
2	<b>Back Rest Module</b> <small>ITEM SKU: MSLAARBK</small>	
2	<b>Scatter Cushion</b> <small>ITEM SKU: MSLAARBK</small>	

# 2.5 Seater Low Arm Sofa with Chaise Covers

Total boxes: 1

## BAG 1

QTY	ITEM
-----	------

---

1

Low Arm Seat Cover

ITEM SKU: MSLASE-COV

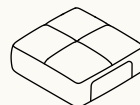

---

## BAG 2

QTY	ITEM
-----	------

---

1

Low Arm Chaise Cover

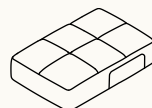

ITEM SKU: MSLACHSE-COV



# 2.5 Seater Low Arm Sofa with Chaise Covers

Total boxes: 1

## BAGS 3 & 4

QTY	ITEM	
2	<b>Low Arm Cover</b> <small>ITEM SKU: MSLAARBK-COV</small>	
2	<b>Backrest Cover</b> <small>ITEM SKU: MSLAARBK-COV</small>	
2	<b>Scatter Cushion Cover</b> <small>ITEM SKU: MSLAARBK-COV</small>	

# Let's put the cover on the Seat Module.

The following steps apply to Low Arm Seat, High Arm Seat, Armless Seat, High Arm Chaise, Low Arm Chaise and Ottoman modules.

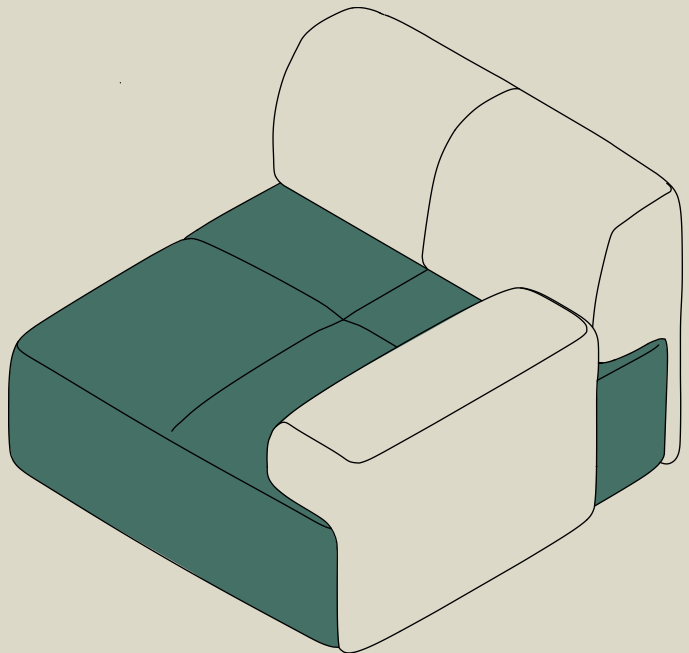

STEP 01

Identify the seat cover by the label on the bottom.

Ensure the labels on your seat module and cover match.

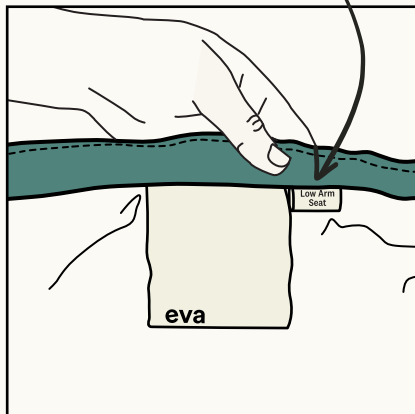
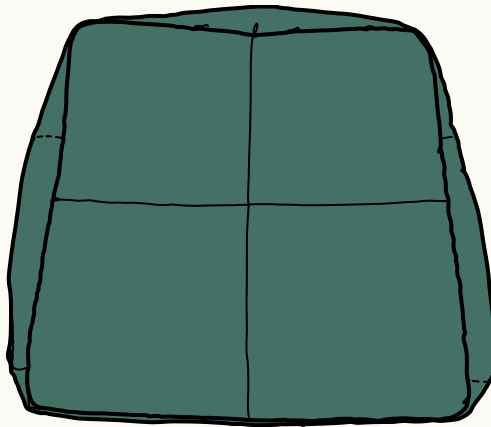
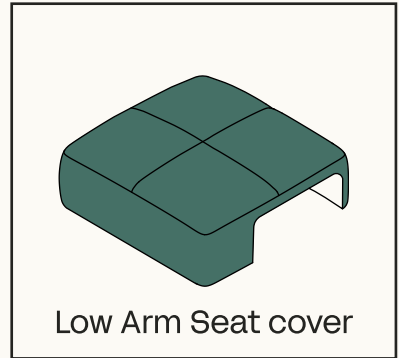



## STEP 02

Place the cover on top of the  
Low Arm Seat Module  
as seen below.



The cover opening  
should frame the seat  
module brackets.

## STEP 03

Fix the covers tightly over each corner of the Low Arm Seat Module.

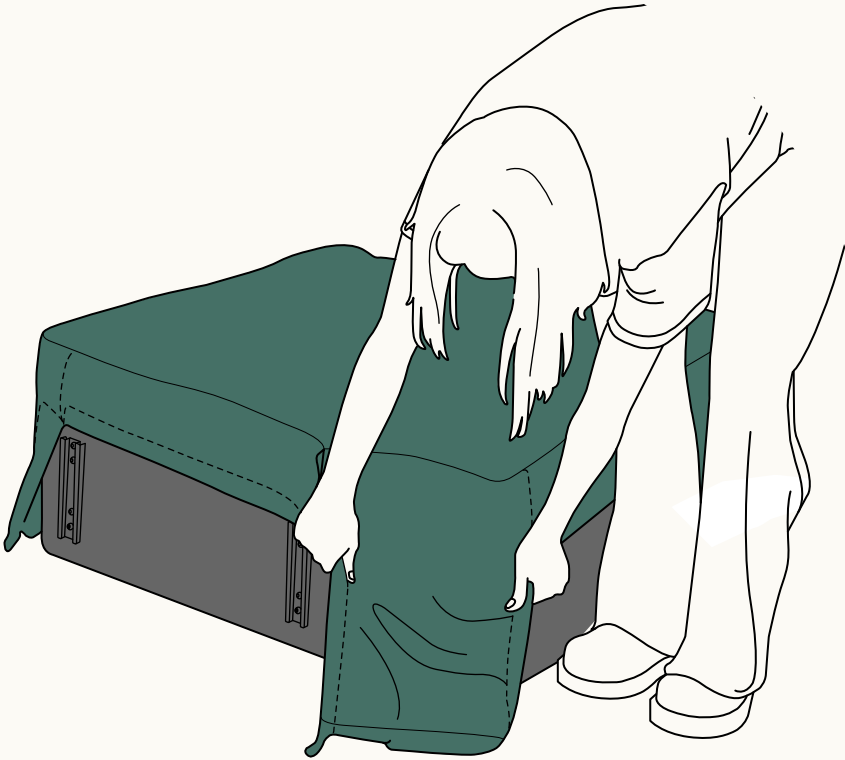

## STEP 04

Flip the Low Arm Seat  
Module upside down.

Unfold the hook and loop  
along all edges of the cover  
and fix the covers to the  
base of the module.

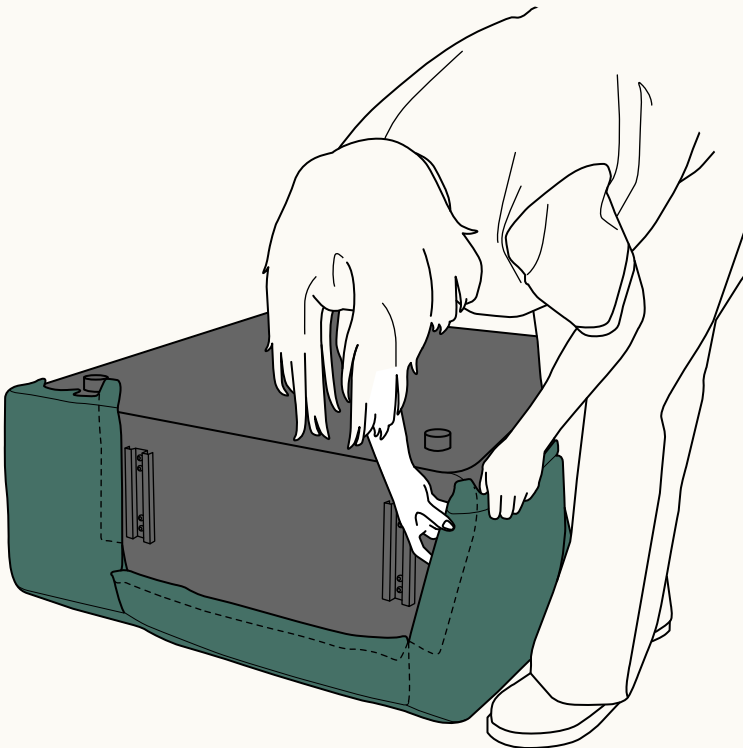
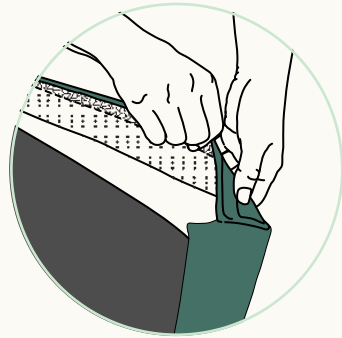

## STEP 05

Attach the cover to the Low Arm Seat Module by securing each edge along the sides.

Slide the cover into the groove on top of the brackets to prevent them from snagging.

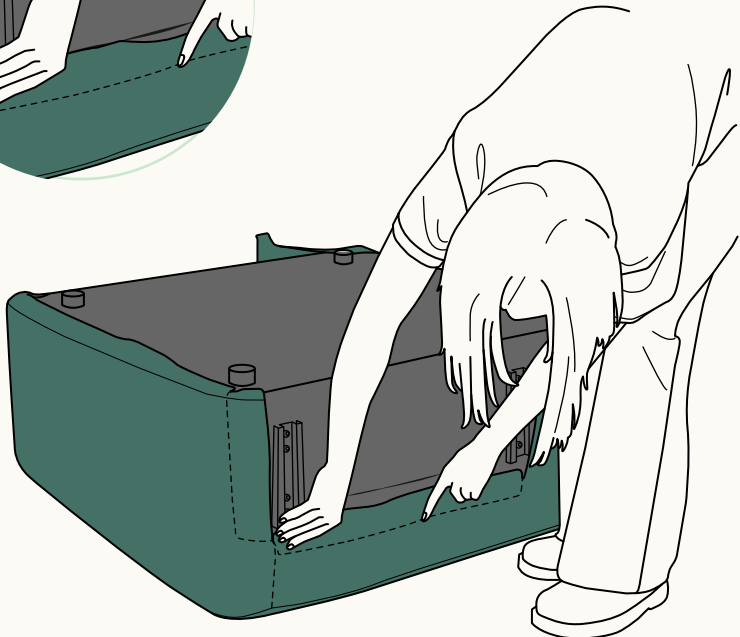
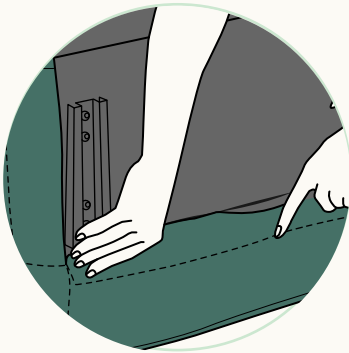

## STEP 06

If the cover's wrinkle, easily smooth them by laying a towel over the fabric and gently ironing out any visible creases.

Please follow the care label instructions on your cover's for ideal heat settings.

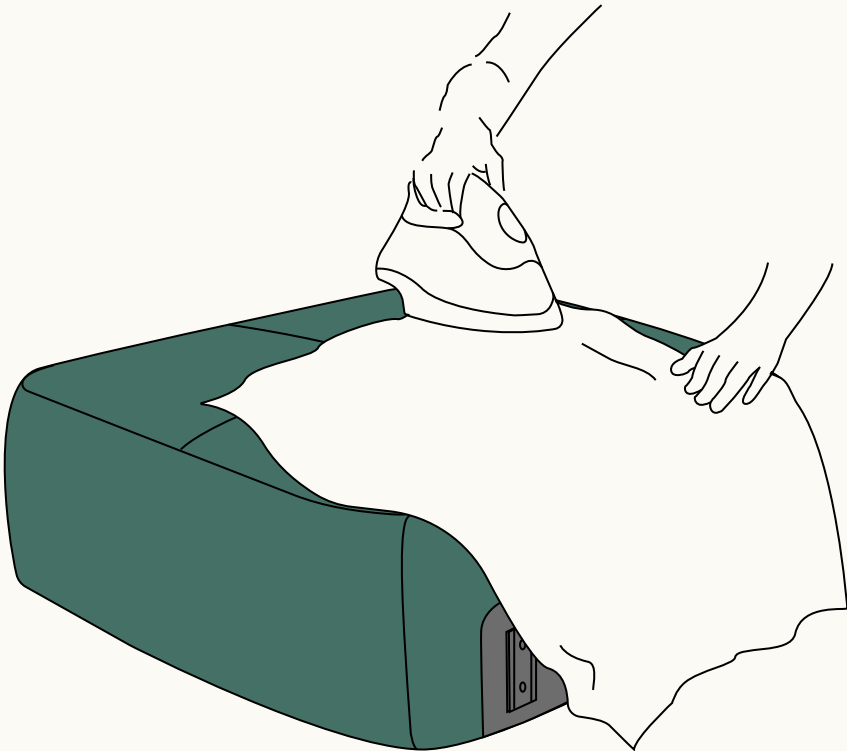

Repeat these steps to assemble the covers to the other half of the sofa.

Once your Seat covers are on, let's move onto the Backrests.



Let's put the cover  
on the Backrest Module.

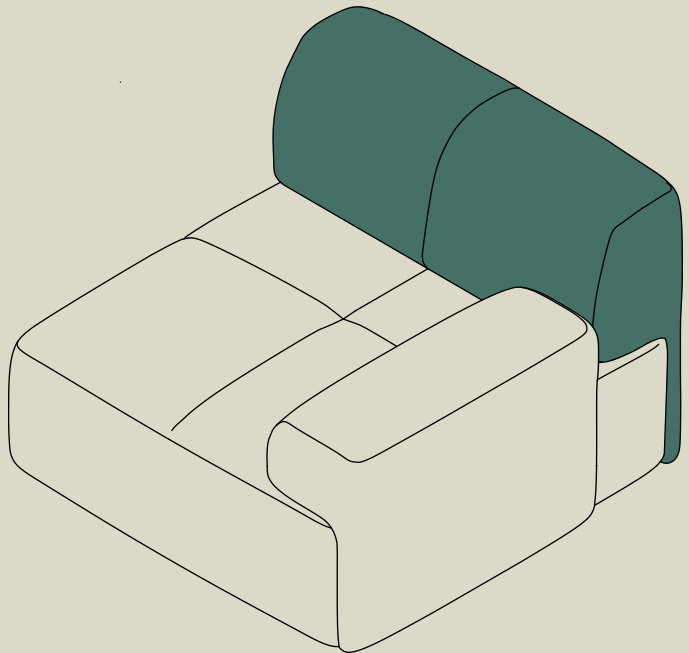

STEP 01

Identify the Backrest cover by the label on the bottom.

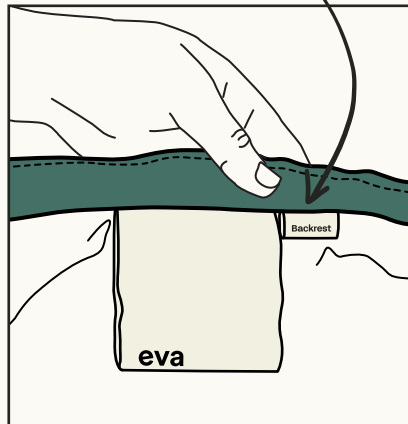
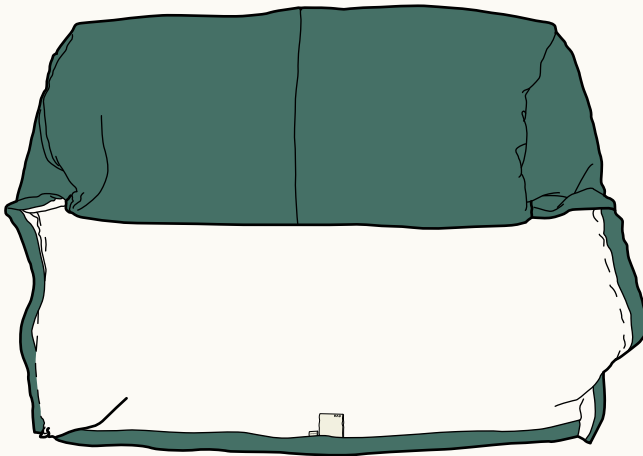
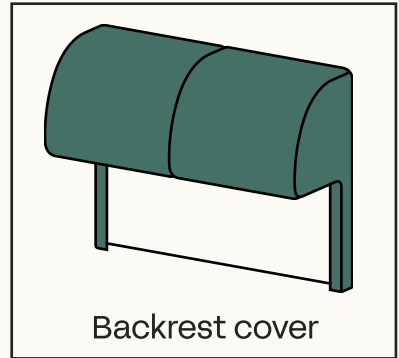



STEP 02

Dress the top part first, starting by roughly fitting one side.

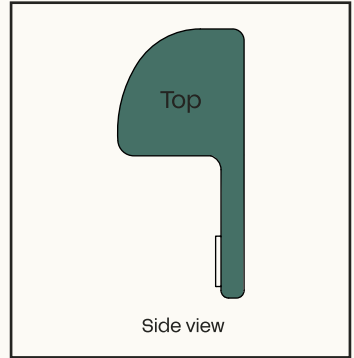

Leave this side partially attached. Do not push the cover all the way down yet.

## STEP 03

Fit both sides alternately until the whole top part is fixed onto the module.

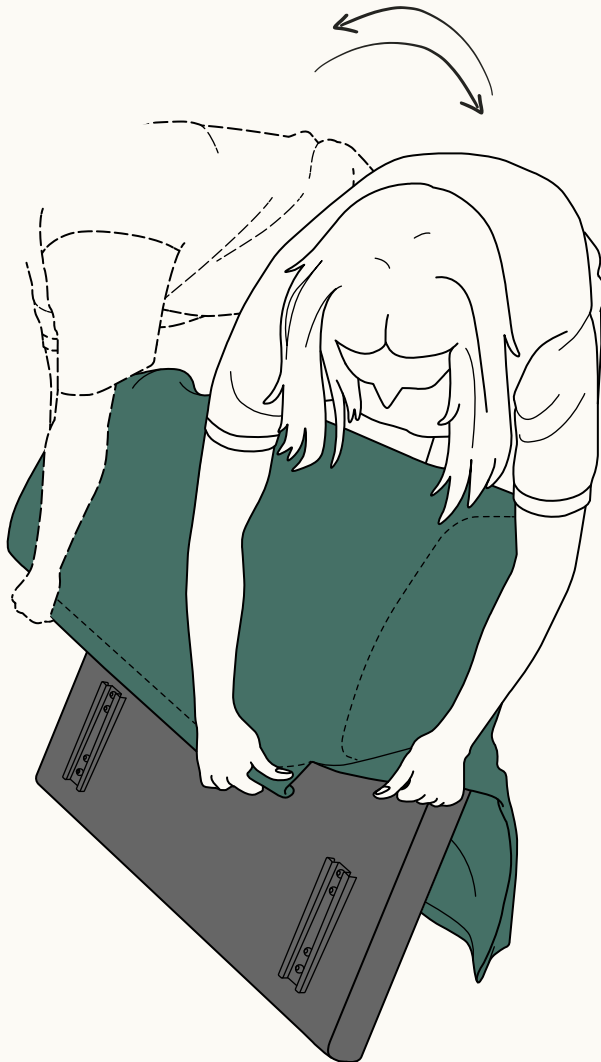

## STEP 04

Flip the Backrest module upside down and pull the cover over the bottom of the Backrest.

Unfold the hook and loop along all edges of the cover.

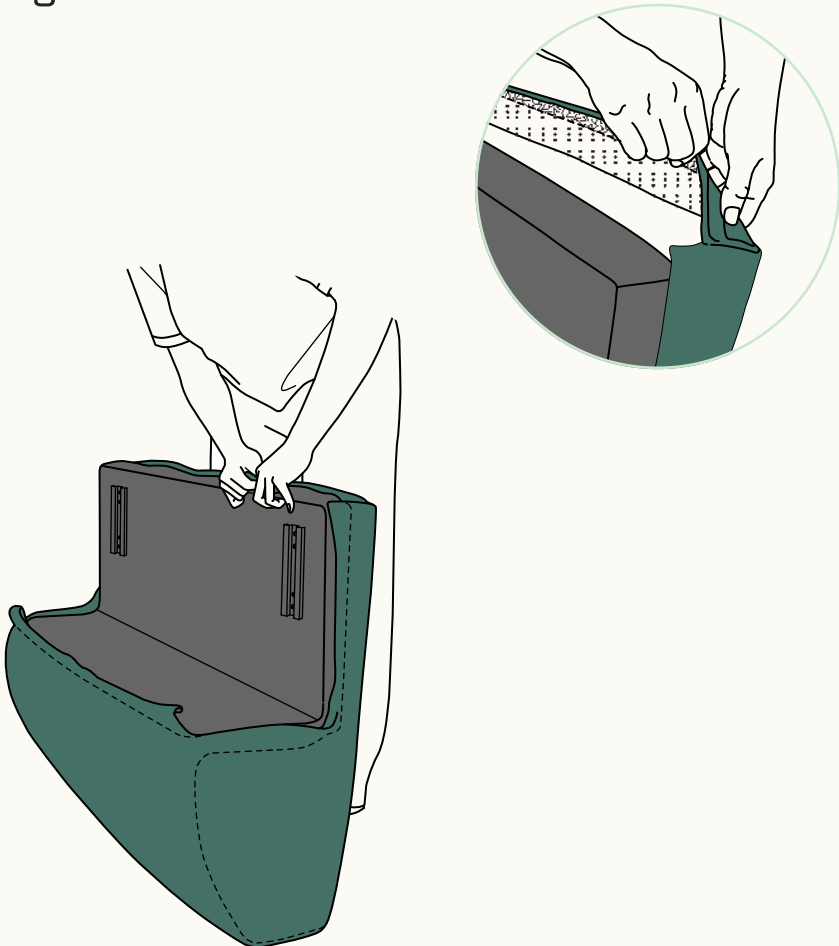

## STEP 05

Adjust the cover seams to align neatly with the Backrest's edges.

Secure all hook and loop to finish the cover installation.



## STEP 06

If the cover's wrinkle, easily smooth them by laying a towel over the fabric and gently ironing out any visible creases.

Please follow the care label instructions on your cover's for ideal heat settings.



Repeat these steps to dress the remaining Backrest Modules.

Once your Backrest covers are on, let's move onto the arms.

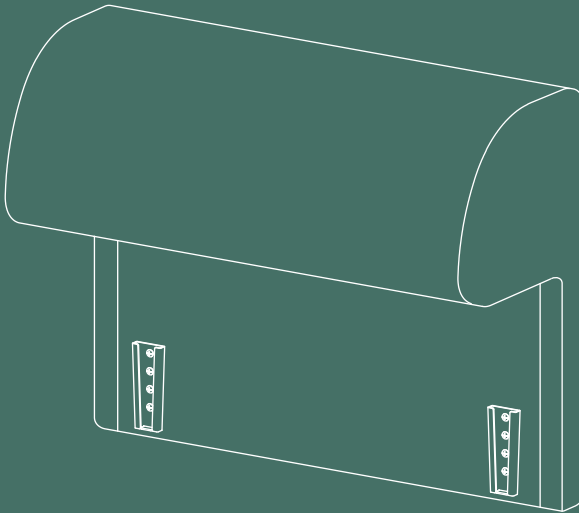

Let's put the cover on the  
Low Arm Module.

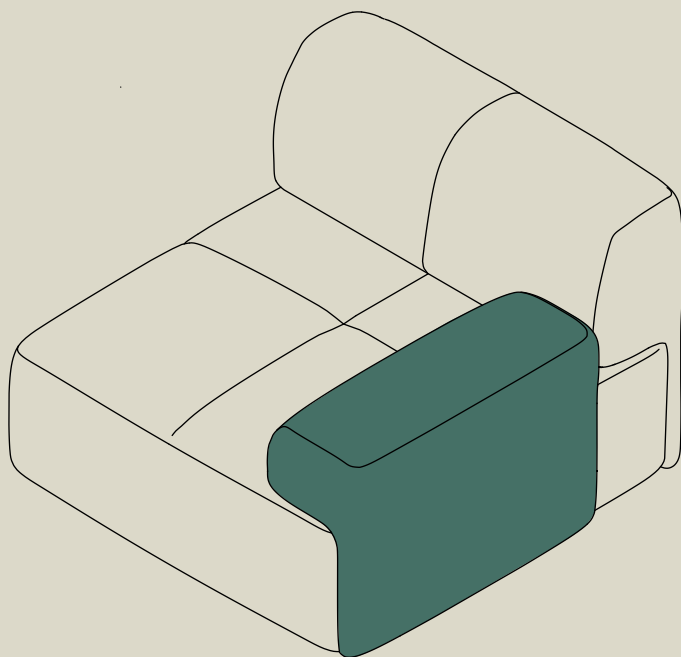

STEP 01

Identify the Low Arm cover by the label on the bottom.

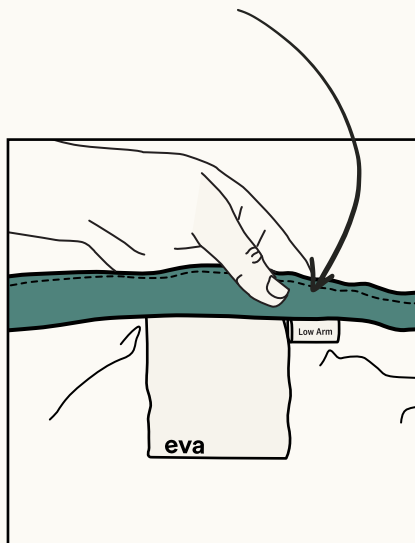
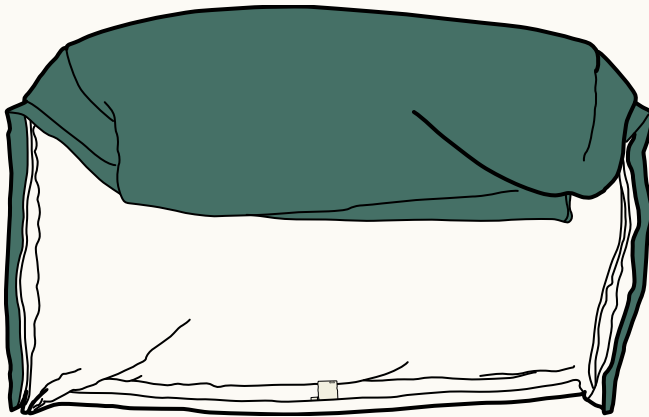
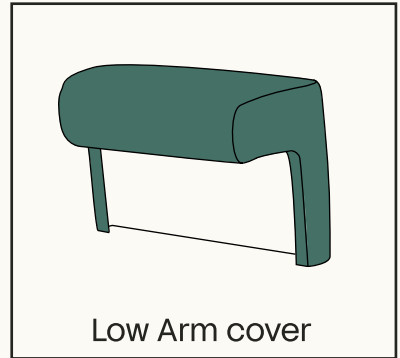



STEP 02

Fit one side of the cover to the Low Arm Module.

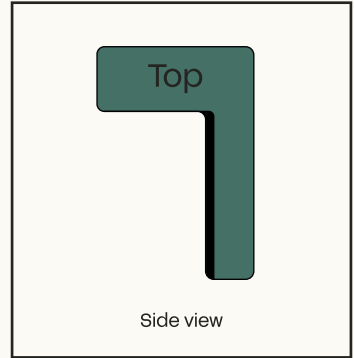

Attach loosely and do not push the cover all the way down yet.

## STEP 03

Fix each end of the cover so it fits tightly over the top section of the Low Arm Module.

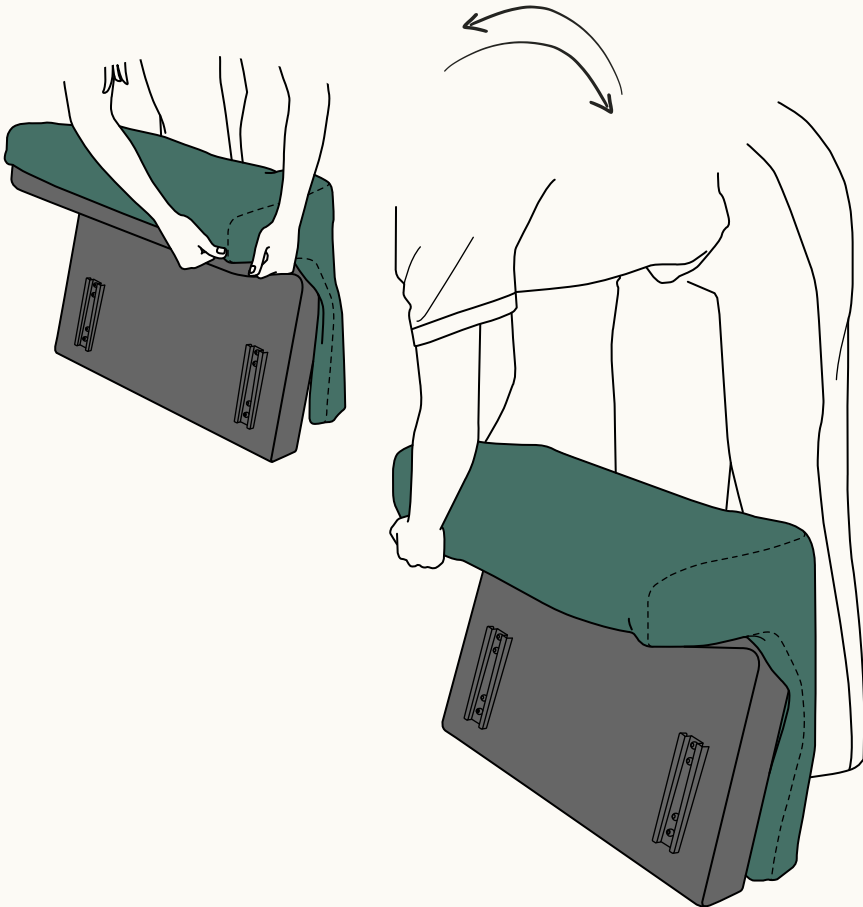

## STEP 04

Flip the Low Arm Module upside down and pull the cover over it's bottom edge.

Unfold the hook and loop along all edges of the cover.

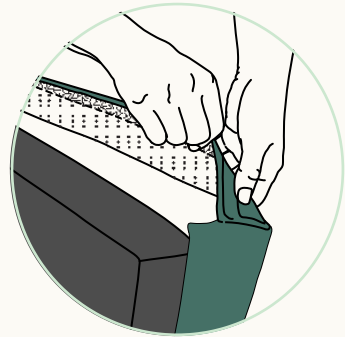
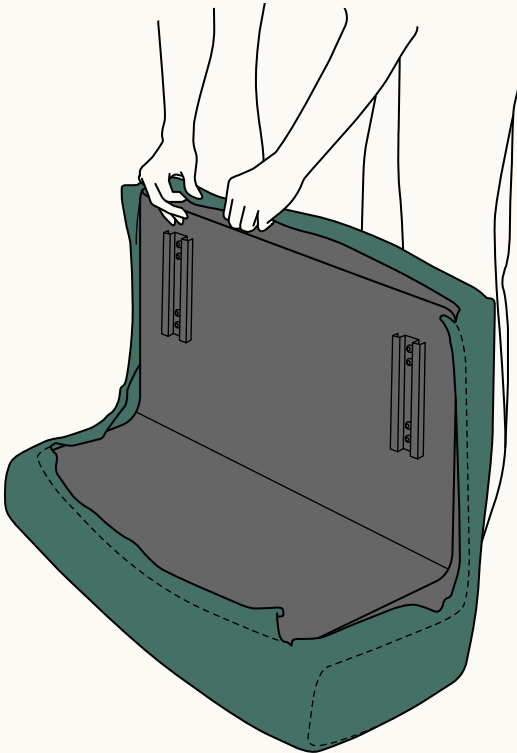

## STEP 05

Adjust the cover seams to align neatly with the Low Arm's edges.

Secure all hook and loop to finish the cover installation.

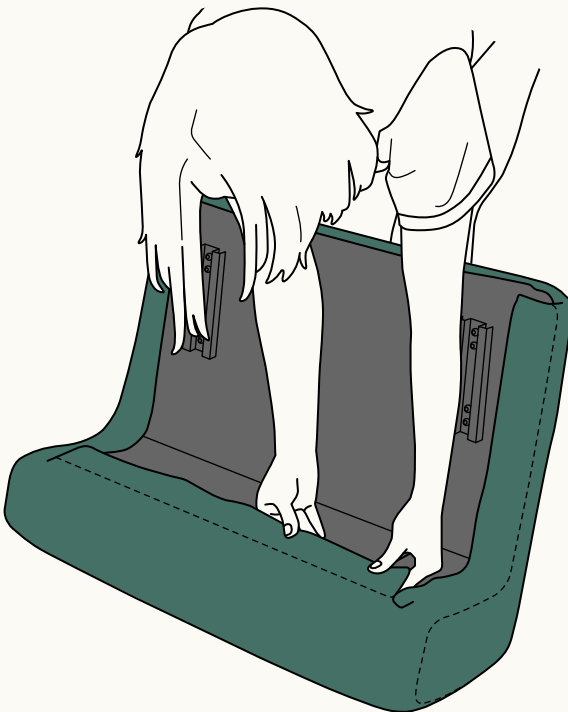

## STEP 06

If the cover's wrinkle, easily smooth them by laying a towel over the fabric and gently ironing out any visible creases.

Please follow the care label instructions on your covers for ideal heat settings.



Repeat these steps to assemble the covers to the other half of the sofa.

Once your Low Arm covers are on, let's move to assembling your sofa.

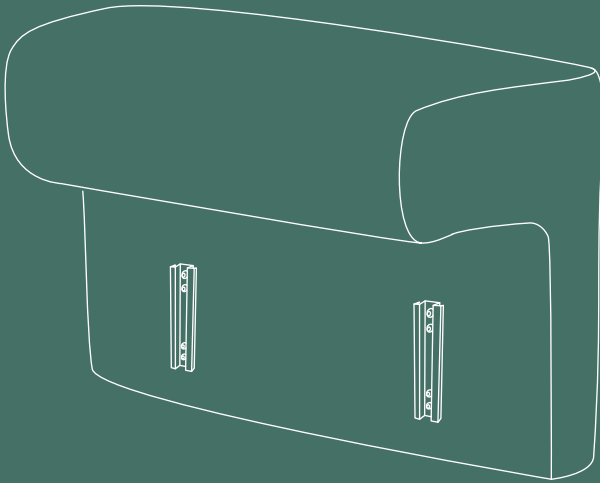

First, let's assemble  
the Low Arm Section.

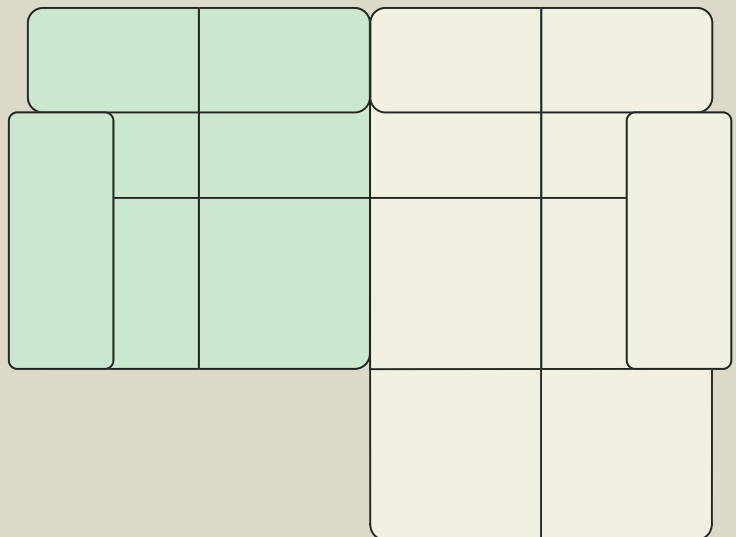

## STEP 01

Align the brackets between the Backrest and the Seat and slide into place.

We recommend having one person slide the Backrest piece on whilst the other holds the Seat in place.

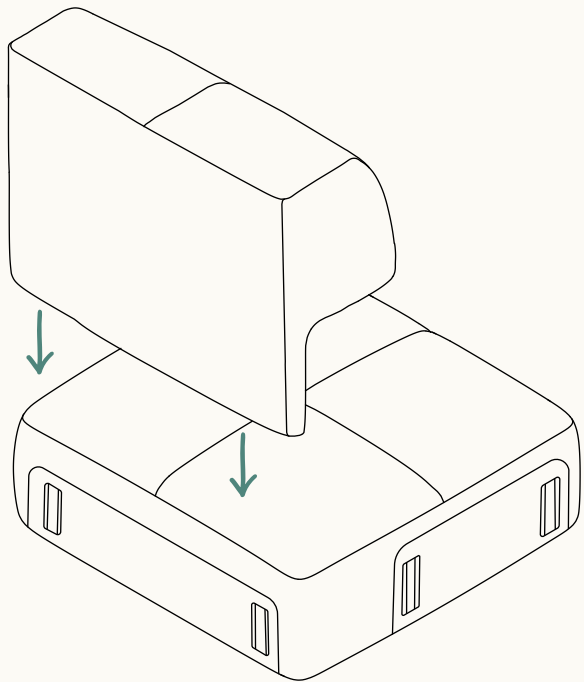
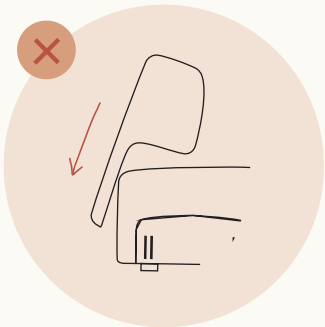
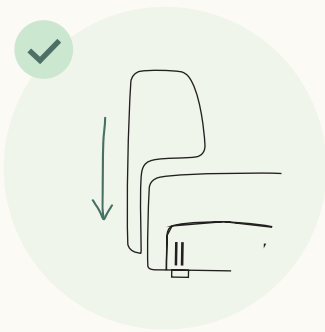



## STEP 02

Align the brackets between the Low Arm and the Seat and slide into place.

We recommend having one person slide the Low Arm piece on whilst the other holds the Seat in place.

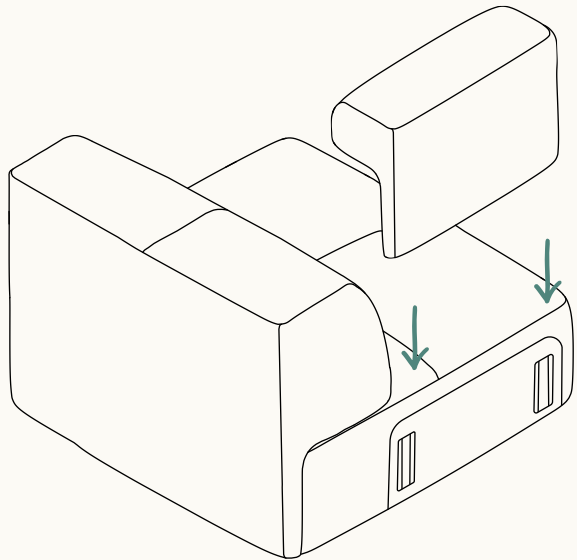
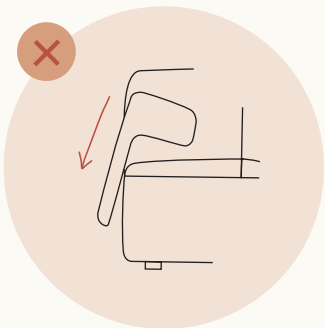
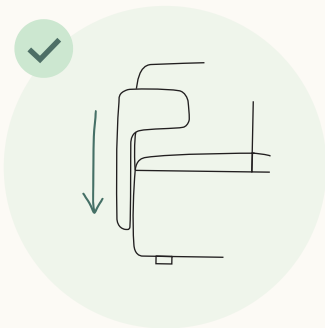

STEP 03

This module is now assembled.

Great job!

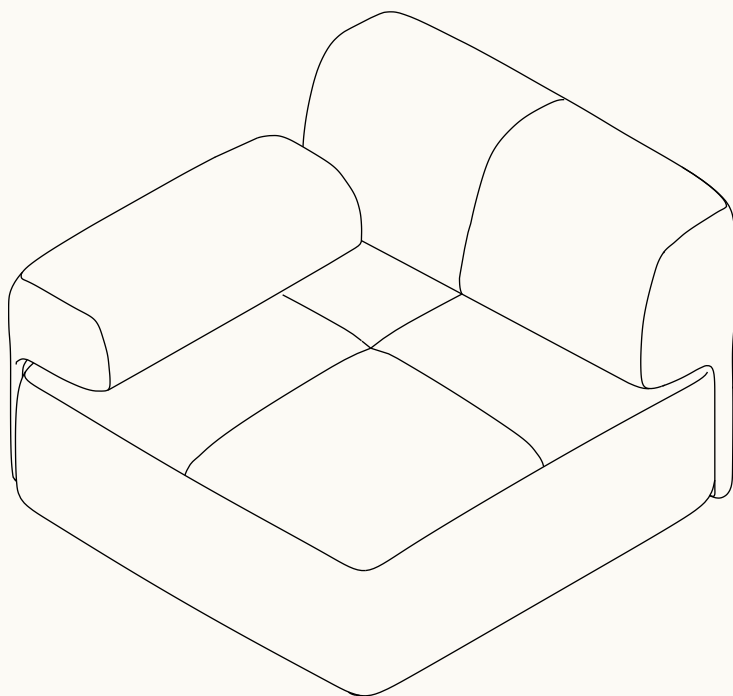

Now let's assemble  
the Chaise Section.

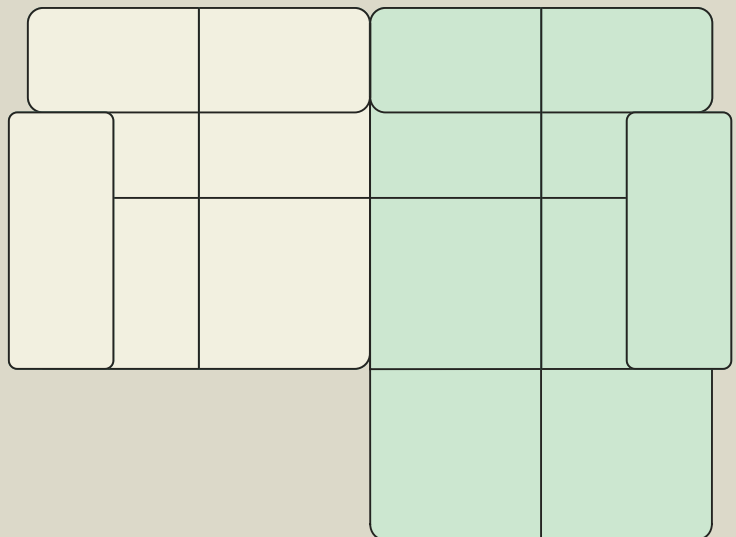

## STEP 01

Align the brackets between the Backrest and the Chaise and slide into place.

We recommend having one person slide the Backrest piece on whilst the other holds the Chaise in place.

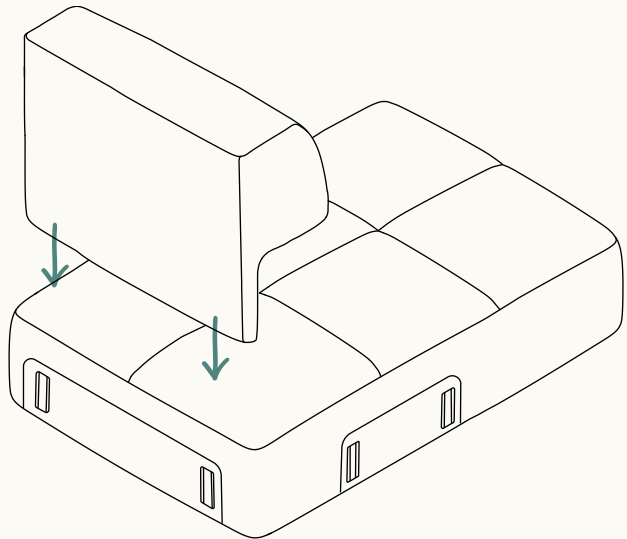
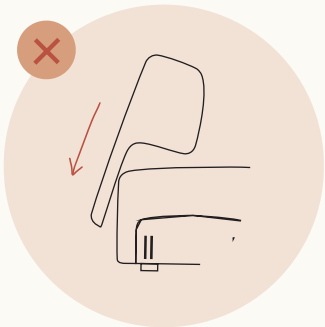
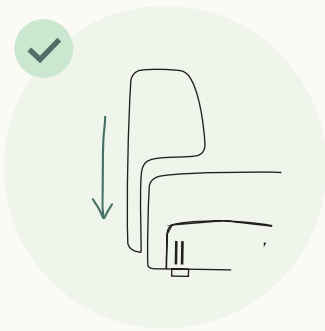

## STEP 02

Align the brackets between the Low Arm and the Chaise and slide into place.

We recommend having one person slide the Low Arm piece on whilst the other holds the Chaise in place.

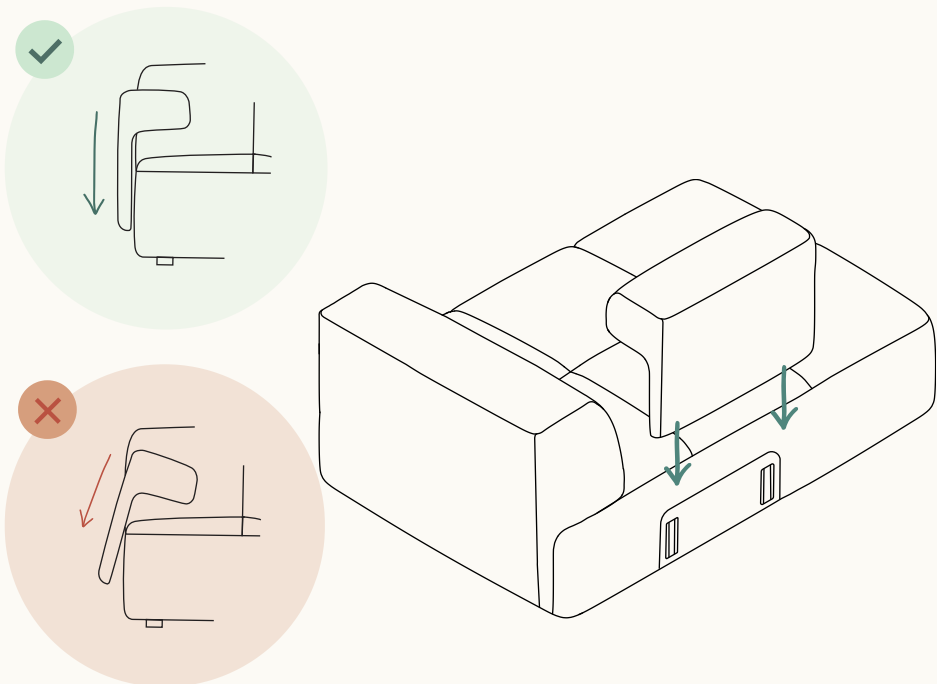

STEP 03

This module is now assembled.

Great job!

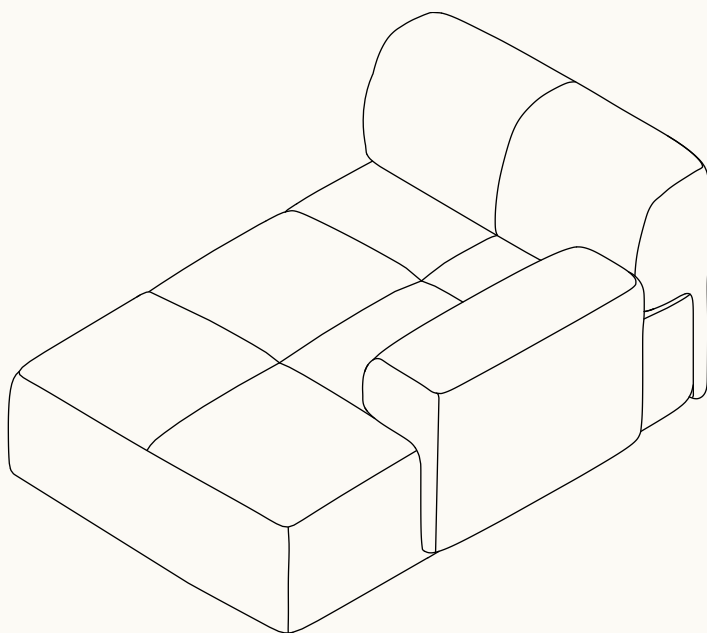

Now let's assemble your sofa.

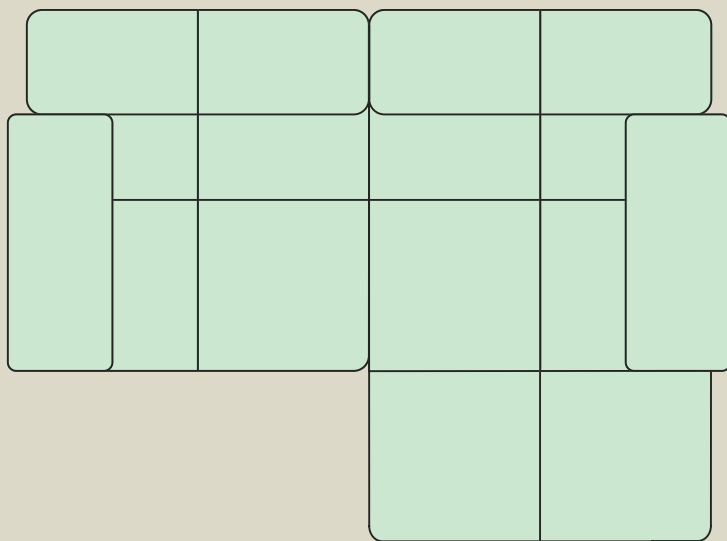

STEP 01

Rotate the connector  
brackets out.

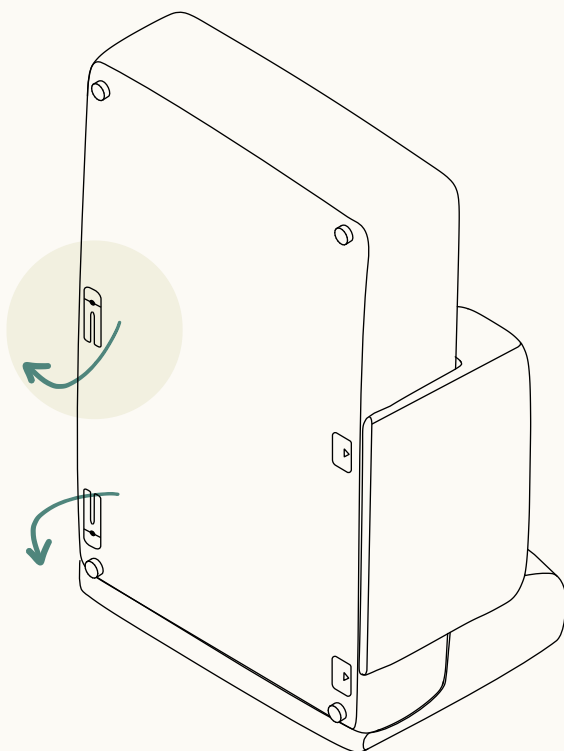



## STEP 02

Align connectors and push modules together.

The connectors will click together and lock the modules into place.

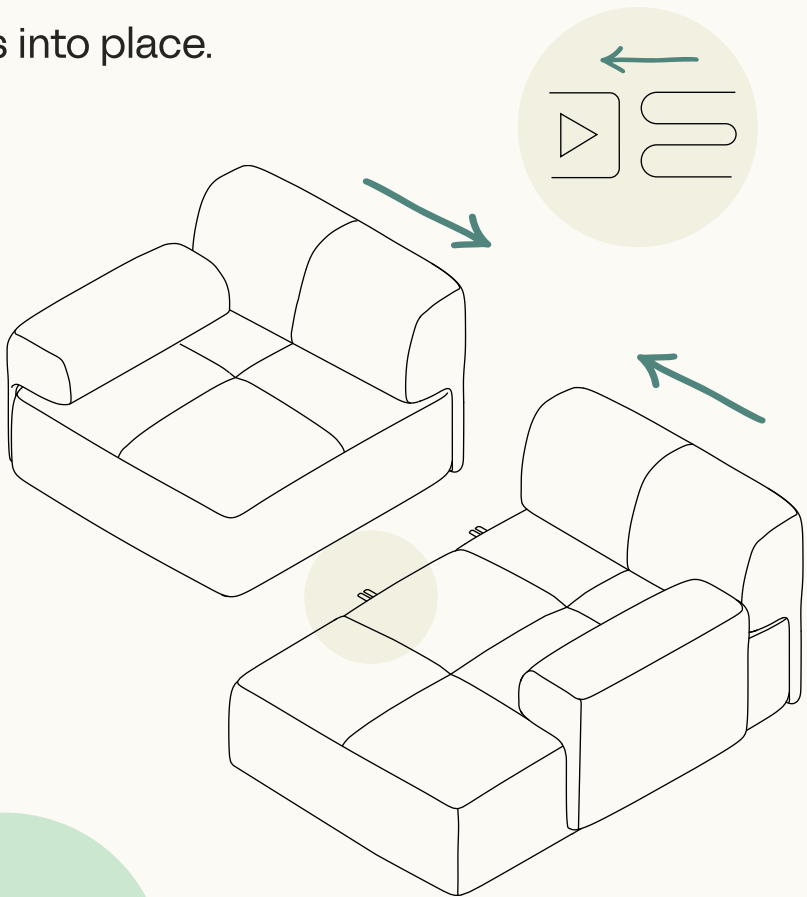

To disconnect the modules, simply lift them up to detach the connectors.

It's time to sit back and relax! Add your scatter cushions and enjoy your Everyday Sofa!

